

## LEO-Record

Digital gauge with memory function

### Features

- High accuracy
- Insulated and encapsulated piezoresistive pressure sensor
- Pressure and temperature recording
- Non-volatile memory ensures a high degree of data security
- Very low power consumption, long battery life
- Optional: Intrinsically safe version LEO-Record-Ei available for use in explosive environments

### Functions

- Wide range of pressure units to choose from
- 5 user-defined pressure units configurable via software
- Zero point calibration via buttons
- Record function can be stopped and started manually
- Various configurable recording functions

### Typical applications

- Long-term monitoring and logging
- Water supply line monitoring
- Leakage monitoring
- Pressure monitoring in oil fields
- Gas line pressure checking



#### Accuracy

± 0,05 %FS

#### Total error band

± 0,1 %FS

#### Pressure ranges

-1...3 bar to 0...1000 bar

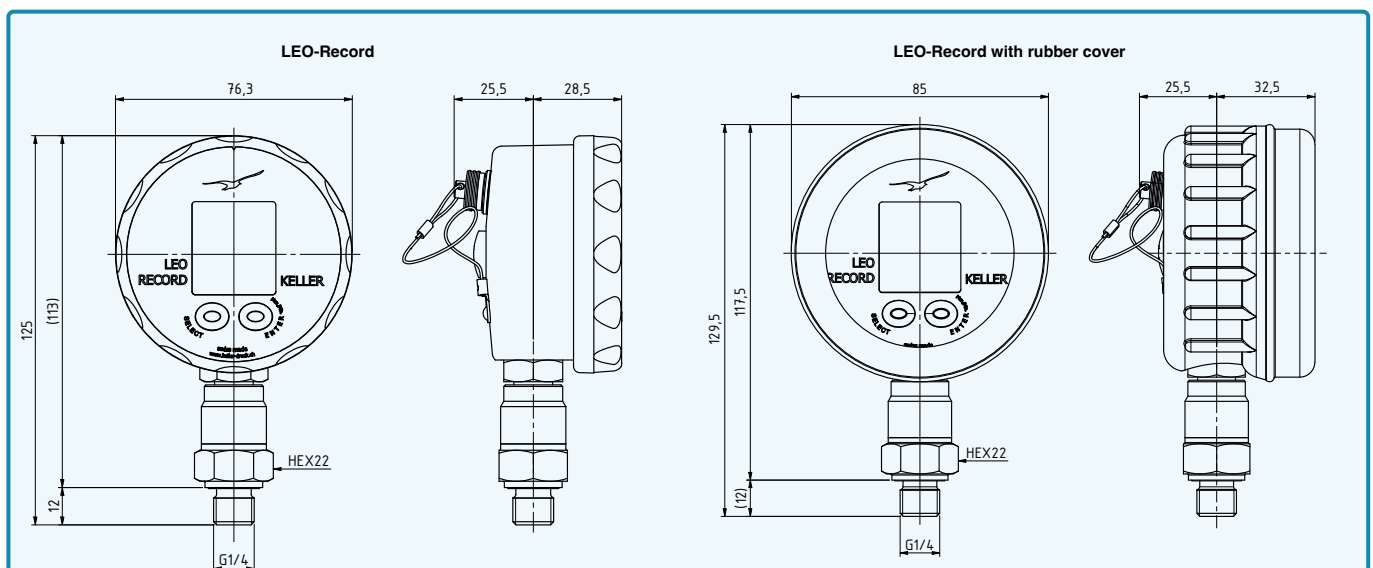

## LEO-Record – Specifications

### LEO-Record piezoresistive standard pressure ranges

Relative pressure PR	Absolute pressure PAA	Absolute pressure PA	Proof pressure	Display resolution
-1...3	0...4		10	0,001
-1...10	0...11		30	0,001
-1...30	0...31		90	0,01
	0...61		180	0,01
	0...101		300	0,01
		0...300	600	0,1
		0...700	1200	0,1
		0...1000	1200	0,1
bar rel.	bar abs.	bar abs.	bar	bar
Reference pressure at atmospheric pressure	Reference pressure at 0 bar abs. (vacuum)	Reference pressure at 1 bar abs.	Relating to Reference pressure	

### LEO-Record capacitive standard pressure ranges

Relative pressure PR	Differential pressure PD	Proof pressure	Negative Proof pressure	Display resolution
0...0,03		0,3	0,03	0,01
0...0,1		1	0,1	0,01
0...0,3		1,5	0,3	0,1
bar rel.	bar diff.	bar	bar	mbar
Reference pressure at atmospheric pressure		Based on reference pressure		

The PD version features a 6 mm diameter capillary connection for reference.

## Performance

### LEO-Record piezoresistive

Accuracy @ RT (20...25 °C)	$\leq \pm 0,05$ %FS	Non-linearity (best fit straight line, BFSL), pressure hysteresis, non-repeatability, zero point deviation and amplification deviation
Total error band (0...50 °C)	$\leq \pm 0,1$ %FS	Maximum deviation within the specified pressure and temperature range
Compensated temperature range	0...50 °C	
Long term stability	$\leq \pm 0,1$ %FS	Per year under reference conditions, annual recalibration recommended
Position dependency	$\leq \pm 1,5$ mbar	Calibrated in vertical installation position with pressure connection facing downwards
Pressure range reserve	$\pm 10$ %	Valid measured values outside the pressure range, no overflow/underflow
Temperature measurement accuracy	$\pm 1$ °C typ.	

## LEO-Record – Specifications

### LEO-Record capacitive

Accuracy @ RT (20...25 °C)	$\leq \pm 0,1$ %FS	Non-linearity (best fit straight line, BFSL), pressure hysteresis, non-repeatability, zero point deviation and amplification deviation
Total error band (0...50 °C)	$\leq \pm 0,2$ %FS	Maximum deviation within the specified pressure and temperature range
Compensated temperature range	0...50 °C	
Long term stability	$\leq \pm 0,1$ %FS	Per year under reference conditions, annual recalibration recommended
Long term stability 30 mbar range	$\leq \pm 0,1$ mbar	
Position dependency	$\leq \pm 0,2$ %FS	Calibrated in vertical installation position with pressure connection facing downwards
Temperature measurement accuracy	$\pm 1$ °C typ.	
Pressure range reserve	$\pm 10$ %	Valid measured values outside the pressure range, no overflow/underflow
Line pressure dependency (PD version)	$\leq \pm 0,005$ %FS / bar	
Line pressure	$\leq 2$ bar	

### Electrical data

Battery	3.6 V lithium battery, type SL-760	For hazardous application areas, only 3.6 V SL-760 batteries from Tadiran are permitted (LEO-Record-Ei)
Battery life	Approx. 2 years	When used continuously with a storage interval of every 10 seconds
External voltage supply	8...28 VDC	LEO-Record-Ei devices cannot be used with an external power supply, and the RS485 interface must not be used in explosive areas.  See operating instructions for further information
Overvoltage and reverse polarity protection of external power supply	$\pm 32$ V DC	
RS485 voltage insulation	-7...12 V DC	
GND - CASE insulation	$> 10$ M $\Omega$ @ 50 VDC	
External interface	RS485 half-duplex	
Interface measuring rate	2/s	
Electrical connection	Female socket D 103 A054-130	

### Electromagnetic compatibility

CE conformity as per 2014/30/EU (EMV)	EN 61326-1 / EN 61326-2-3 / EN 61000-6-1 / EN 61000-6-2 / EN 61000-6-3 / EN 61000-6-4
---------------------------------------	---

### Data logger

Cyclical logger	Recording of pressure and temperature	Various recording functions can be configured
Data storage	57,000 measured values with timestamp	Measurement interval $\leq 15$ s
	28,000 measured values with timestamp	Measurement interval $> 15$ s
Storage interval	Shortest 1/s	Configurable

## LEO-Record – Specifications

### LC display

Dimensions/appearance	Width x height: 27,8 mm x 30 mm (see Dimensions and options)
Number of digits on LC display	2 rows with 5 digits each
Display mode	Pressure and record status
Display interval	2/s
Configurable pressure units	bar, mbar, hPa, kPa, MPa, PSI, mH <sub>2</sub> O, cmH <sub>2</sub> O, kp/cm <sup>2</sup>
Additional pressure units	5 user-defined units can be configured via software

### Mechanical data

#### Materials in contact with media

Component	LEO-Record piezoresistive	LEO-Record capacitive
Pressure connection	Stainless steel AISI 316L	Aluminium oxide 96%, gold plated
Pressure transducer diaphragm		Stainless steel AISI 316L
Pressure transducer seal (internal)	None	Nitrile
Pressure connection seal (external)	FKM (75 Shore, -20...200 °C)	FKM (75 Shore, -20...200 °C)

#### Other materials

Component	LEO-Record piezoresistive	LEO-Record capacitive
Display housing	Faradex AS-1003	Faradex AS-1003
Front glass	LEXAN® 163R	LEXAN® 163R
Pressure transducer oil filling	Silicone oil	None

#### Other data

Component	LEO-Record piezoresistive	LEO-Record capacitive	
Pressure connection	G 1/4 male	G 1/4 male	See Dimensions and options
	1/4-18NPT male	1/4-18NPT male	
Diameter x height x depth	76 mm x 125 mm x 54 mm	76 mm x 150 mm x 55 mm	Without rubber cover
	85 mm x 130 mm x 58 mm	85 mm x 130 mm x 58 mm	With rubber cover
Weight (approx.)	250 g	350 g	Without rubber cover

#### Environmental conditions

Medium temperature range	-40...85 °C	Icing not permitted
Ambient temperature range	-10...60 °C	
Storage temperature range	-20...70 °C	
Protection	IP65	
Note	Readability of the LC display is guaranteed between 0 °C and 50 °C Outside of this temperature range, the readability of the display may be limited	

### LEO-Record-Ei explosion protection

Intrinsically safe version LEO-Record-Ei in accordance with 2014/34/EU (ATEX) and IECEx	Ex II 2G Ex ia IIC T4 Gb PTB 05 ATEX 2012 X IECEx PTB 13.0028 X	The intrinsically safe version may only be operated using the 3.6 V battery, SL-760 from Tadiran  Max. permitted ambient temperature range -20...60 °C
Note	The conditions for safe use can be found in the operating instructions	

# LEO-Record – Dimensions and options

## LC display

Front cover	Content	Dimensions
		Width x height: 27,8 mm x 30,0 mm  Digit size: top: 8,4 mm x 3,8 mm bottom: 6,3 mm x 2,9 mm

## External connection

Placement	Connection	Pin assignment	
	Female socket D 103 A054-130  	Red	Reference point
		1	GND
		2	n.c.
		3	+Vs
		4	RS485A
5	RS485B		

## Available pressure connections

For pressure range ≤ 200 bar

G1/4	1/4-18NPT
DIN EN ISO 1179-2	ASME/ANSI B 120.1

For pressure ranges > 200 bar

G1/4	1/4-18NPT
DIN EN ISO 1179-2	ASME/ANSI B 120.1

Other pressure connections available on request.

## LEO-Record – Dimensions and options

### Other customer-specific options

- Other compensated pressure ranges
- Other compensated temperature ranges
- Parts that come into contact with media made from Hastelloy, Inconel 718 or titanium
- Customer-specific front covers
- Customer-specific firmware with application-specific calculations (e.g. leakage measurement)
- Other sealing materials for pressure transducers
- Other oil filling types for pressure transducers

## LEO-Record – Software, scope of delivery and accessories

### Interface

The LEO-Record gauge has a digital interface (RS485 half-duplex). Details of the communication protocols can be found at [www.keller-druck.com](http://www.keller-druck.com). Documentation, a Dynamic Link Library (DLL) and various programming examples are available to integrate the communication protocol into your own software.

### Interface converters

The connection to a computer is established via an RS485-USB interface converter. Suitable converters are available as accessories. To ensure smooth operation, we recommend the K-114A converter with the corresponding USB connector.

### KOLIBRI Desktop

With the «KOLIBRI Desktop» Windows software, data recorded using KELLER pressure gauges with a recording function can be read and visualised. This data can be exported in CSV, JSON, image, Excel or Word format, as an image, or in other formats for further processing or documentation. Thanks to the intuitive software interface, the digital gauge is easy to configure and the various recording functions provide an optimum level of adaptability to suit the measuring task at hand. In order to convert measurement results directly after reading them, information about the measuring site, for instance parameters relating to water level calculation, can be saved directly in the measuring device.

KOLIBRI Desktop has a free license and is compatible with all products in the KOLIBRI suite.

#### Configuration options

- Configurable pressure and temperature channels
- Configurable storage interval (1s ... 99 days)
- Averaging from a configurable number of measurements
- Recording types
  - Constant interval measurement
  - Event-controlled recordings
    - Recording starts when value exceeded
    - Recording starts when measurement drops below a value
    - Recording starts when value changes
  - Combination of constant and event-controlled recording possible
- Calibration of the zero pressure point
- Start measurement immediately or at a specific time
- Water level calculation
- Data storage Linear or ring storage

### Mano-Config

The ManoConfig program is compatible with various types of KELLER gauges and allows end customers to configure the devices.

#### Range of functions

- Configuring the wait period before automatic shut-down
- Activating/deactivating pressure units
- User-defined pressure units can be programmed
- Calibrating the pressure

### CCS30

#### Measurement recording

- Graphical live visualisation of the measured values in a configurable time interval
- Adjustable measuring and storage interval
- Export function for the measured values recorded (csv, ...)

#### Configuration

- Call up of information (pressure and temperature range, firmware version, serial number etc.)









## LEO-Record – Scope of delivery and accessories

### Scope of delivery

Plastic case	3.6 V lithium battery, type SL-760	Operating instructions D/E/F
		

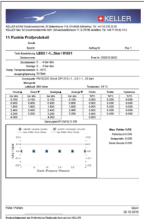
### Accessories

Rubber cover	Carry case	Interface converter
		
For additional protection in harsh environments	With belt loop	K-114-A <ul style="list-style-type: none"> <li>• With Fischer plug (5-pin)</li> <li>• Various adapter cables available</li> </ul>
KELLER 5-point report	KELLER 11-point report	Calibration certificate
		
Measurement deviation at room temperature	Measurement deviation at room temperature with hysteresis	Issued by the external calibration laboratory of the German accreditation body DAkkS or the Swiss accreditation body SAS